

OPERATING MANUAL

TRITON 300 P



Edition: 4 | effective from: 1. 1. 2022

Dear customer,

Semi-carried cultivators **TRITON** are quality products of Farmet a.s. Ceska Skalice.

You can fully utilise the advantages of your machine after thoroughly studying the operating manual.

The serial number of the machine is punched on the production label and written in the operating manual (see Table 1). This machine serial number must be stated whenever ordering spare parts for possible repairs. The production label is located on the middle frame near the tow bar.

Use only spare parts for these machines according to the **Spare parts catalogue** officially issued by the manufacturer, Farmet a.s. Ceska Skalice.

Possibilities of Use of the Cultivator

The **TRITON** cultivator is designed for cultivation of all types of soils up to a processing depth of 350 mm.

Production label of the machine **TRITON 300 P**

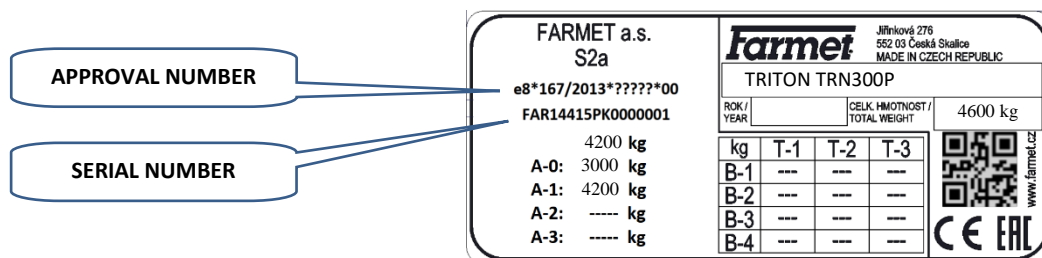

Table 1 – Your Machine Characteristic

MACHINE TYPE	
MACHINE SERIAL NUMBER	
SPECIAL DESIGN OR ACCESSORIES	
.....	
.....	
.....	
.....	

TABLE OF CONTENTS

MACHINE LIMIT PARAMETERS	4
Technical parameters.....	4
Safety statement	5
A. GENERAL INTRUCTIONS FOR USE.....	6
Protective tools	6
B. MACHINE TRANSPORT USING TRANSPORT MEANS	7
C. MACHINE HANDLING USING LIFTING EQUIPMENT	8
D. WORK SAFETY LABELS	9
1. DESCRIPTION	12
1.1 Machine section arrangement	12
2. HYDRAULICS	15
2.1 Description of machine hydraulics	17
2.2 Using the hydraulics control panel.....	18
3. MACHINE ASSEMBLY AT THE CUSTOMER	20
4. COMMISSIONING	20
5. AGGREGATION TO A TRACTOR	21
6. MACHINE TRANSPORT ON ROADS	22
6.1 Scharp machine projection.....	24
7. MACHINE ADJUSTMENT	25
7.1 Working depth adjustment	25
7.2 Adjusting the levelling discs	28
8. MACHINE MAINTENANCE AND REPAIRS.....	29
9. MACHINE STORAGE.....	33
10.MACHINE LUBRICATION SCHEDULE	34
11.ENVIRONMENTAL PROTECTION.....	35
12.MACHINE DISPOSAL AFTER SERVICE LIFE EXPIRITY	35
13.SERVICING AND WARRANTY CONDITIONS.....	35
CE Certificate of Conformity	36

MACHINE LIMIT PARAMETERS

- ^(x) The machine is designed for soil cultivation when agricultural soil cultivation. Another type of use exceeding the determined purpose is forbidden.
- ^(x) The machine is only operated by one person - the tractor operator.
- ^(x) Machine operator must not use the machine in a different way, especially:
 - ^(x) Transport of persons and animals on the machine structure,
 - ^(x) Transport of burdens on the machine structure,
 - ^(x) Aggregation of the machine with another towing equipment than stated in Chapter „5./p.21“.

TECHNICAL PARAMETERS

TTable 2 – Technical Parameters

PARAMETERS		TRITON 300 P	
Working width (mm)		3000	
Transport width (mm)		2983	
Transport height (mm)		1740	
Machine total length (mm)		9460	
Working depth (mm) shares/discs		100-350/50-120*	
Number of shares		7	
Number of discs		22	
Working performance (ha/h)		2,4-3,6	
Towing means (kW)		150-235**	
Working speed (kph)		8-12	
Maximum transport speed (kph)		30	
Maximum slope grade (°)		6	
Tyre dimensions - transport port	Tyre pressure (kPa)	19.0/45-17	400
Machine weight (kg)		4600***	

*For discs 510 a 560

mm. working depth setting is described in detail in Chap. 7.1/p.25

**Recommended towing means, the real towing force may significantly vary according to the processing depth, soil conditions, land slope, working body wear and adjustment

***For the heaviest version with a double roller and an additional weight

Weight distribution on the machine during transport

Version with a segmented roller



Version with a double roller



SAFETY STATEMENT



This warning sign warns about an immediate dangerous situation ending with death or severe injury.



This warning sign warns about a dangerous situation ending with death or severe injury.



This warning sign warns about a situation that may end with a smaller or slight injury. It also warns about dangerous actions related to the activity that could lead to an injury.

A. GENERAL INSTRUCTIONS FOR USE

- ^(x) The machine is made in accordance with the latest equipment state and approved safety regulations. However, dangers of user or third person injury or machine damage or creation of other material damage may arise during use.
- ^(xx) Use the machine only in a technically sound condition, in accordance with its purpose, aware of possible dangers, and while adhering to the safety instructions of this operating manual!
The manufacturer is not liable for damages caused by the use of the machine that is in contradiction with the limit parameters of the machine and with the instructions for the use of the machine. The user bears the risk.
Immediately remove especially the failures that may negatively affect safety!
- ⁽⁷⁾ Machine operation may be performed by a person authorised by the operator under these conditions:
 - ⁽⁸⁾ It must own a valid driver's licence of the corresponding category,
 - ⁽⁹⁾ It must be demonstrably familiarised with the safety regulations for work with the machine and must practically master the machine operation,
 - ⁽¹⁰⁾ The machine may not be operated by juveniles,
 - ⁽¹¹⁾ It must know the meaning of the safety signs located on the machine. Their respecting is important for safe and reliable machine operation.
- ⁽¹²⁾ Maintenance and servicing repairs on the machine may only be performed by a person:
 - ⁽¹³⁾ Authorised by the operator,
 - ⁽¹⁴⁾ Educated in the machinery field with knowledge of repairs of similar machines,
 - ⁽¹⁵⁾ Demonstrably familiarised with safety regulations for work with the machine,
 - ⁽¹⁶⁾ During a repair of a machine connected to a tractor, it must own a driver's licence of the corresponding category.
- ⁽¹⁷⁾ Machine operator must secure the safety of other persons when working with the machine or transporting the machine.
- ⁽¹⁸⁾ During machine work in the field or during transport, the operator must control the machine from the tractor's cabin.
- ⁽¹⁹⁾ The operator may enter the machine structure only with the machine at rest and blocked against movement, namely only for these reasons:
 - ⁽²⁰⁾ Adjustment of the machine working parts,
 - ⁽²¹⁾ Repair and maintenance of the machine,
 - ⁽²⁹⁾ Release and securing of spherical valves of the axle,
 - ⁽²⁷⁾ Securing of spherical valves of the axle before folding the side frames,
 - ⁽²⁸⁾ Adjustment of the working parts of the machine before work.
- ^(xxx) When climbing on the machine, do not step on the axle tyres, rollers or other revolving parts. Those may turn and you can cause very serious injuries by the subsequent fall.
- ⁽²²⁾ Any changes or modifications of machine may be performed only with written consent of the manufacturer. For possible damage arisen due to ignoring this instruction, the producer bears no responsibility. The machine must be maintained equipped with prescribed accessories and equipment including safety marking. All warning and safety signs must be legible and in their places. In case of damage or loss, these signs must be immediately renewed.
- ⁽²³⁾ The operator must have the Operating Manual with the work safety requirements available at any time when working with the machine.
- ⁽²⁴⁾ The operator must not consume alcohol, medicines, narcotic and hallucinogenic substances that decrease his attention and coordination capabilities while using the machine. If the operator must use medicines prescribed by a physician or uses freely sold medicines, he must be informed by a physician, whether he is capable of responsible and safe operation of the machine under these circumstances.



PROTECTIVE TOOLS

For the operation and maintenance use

- Tight clothes
- Protective gloves and goggles for protection against dust and sharp parts of the machine



B. MACHINE TRANSPORT USING TRANSPORT MEANS

- B.1 ⁽¹⁾ The transport means designed for machine transport must have the load capacity minimally identical with the weight of the transported machine. The total weight of the machine is stated on the production label.
- B.2 ⁽²⁾ The dimensions of the transported machine including the transport means must comply with the valid regulations for road traffic (decrees, laws).
-  B.3 ⁽³⁾ The transported machine must be always fastened to the transport means so that its spontaneous loosening could not happen.
- B.4 ⁽⁴⁾ The carrier is responsible for damage caused by the loosening of incorrectly or insufficiently fastened machine to the transport means.
- B.5 ⁽⁵⁾ To fasten the machine, use the recommended points shown in the picture: slings and the central frame of the machine.
- B.6 ⁽⁵⁾ All ball valves must be closed.

PLACE FOR MACHINE FASTENING

- The points for fastening are shown in red

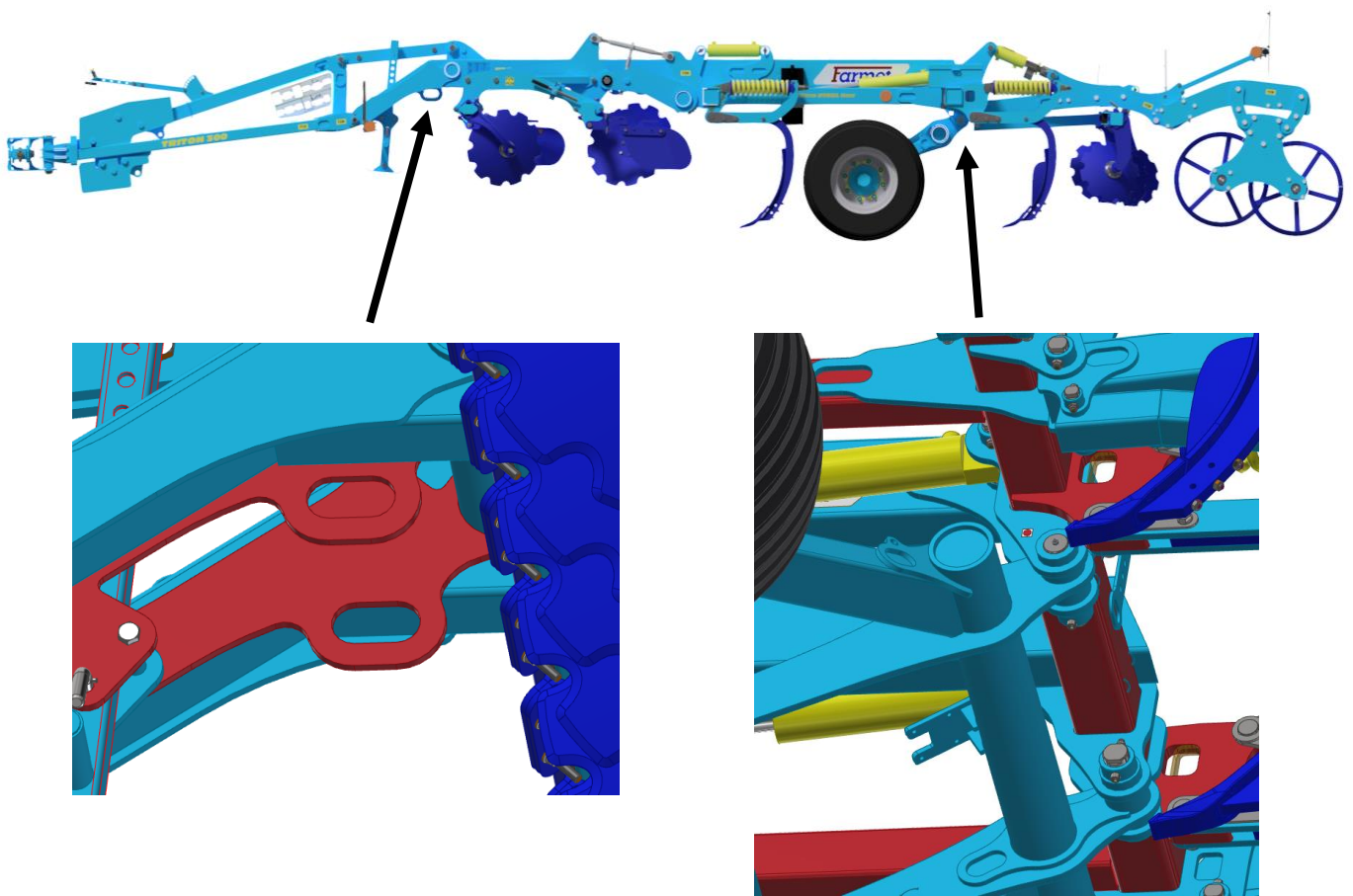

C. MACHINE HANDLING USING LIFTING EQUIPMENT

C.1 ⁽¹⁾ The lifting equipment and tying means designed for handling of the machine must have their load capacity at least identical with the weight of the handled machine.



C.2 ⁽²⁾ Machine fastening for handling may only be performed in places designed for that and marked with self-adhesive labels showing the "chain" symbol. —○—○—

C.3 ⁽³⁾ After fastening (suspending) at designated points, it is forbidden to move in the space of possible reach of the handled machine.

C.4 ⁽⁴⁾ Do not use the lugs on the roller supports under any circumstances when manipulating with the whole machine. The lugs are only designed for replacing rollers and their maximum load capacity is 500 kg (as shown on the label near the lugs).

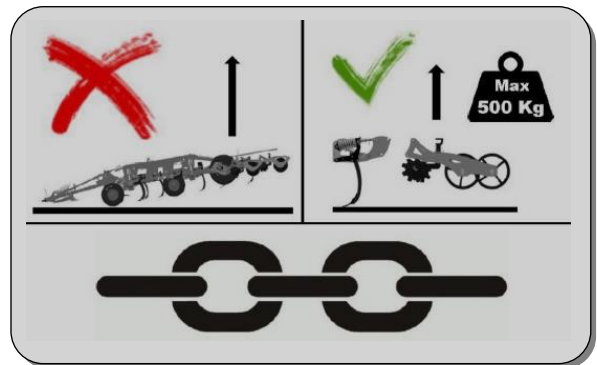
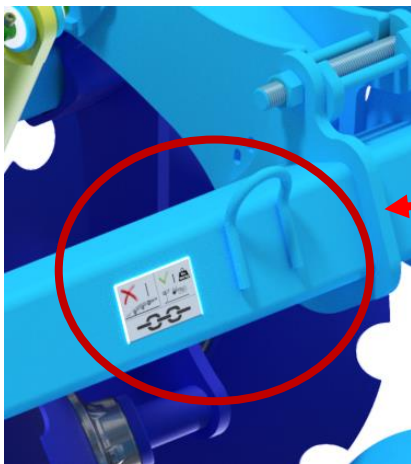

D. WORK SAFETY LABELS

Warning safety labels serve for operator protection.

General:

A) Strictly observe the warning safety labels.

B) All safety instructions also apply to other users.

C) Upon damage or destruction of the aforementioned "SAFETY LABEL" located on the machine, THE OPERATOR IS OBLIGED TO REPLACE IT WITH A NEW ONE!!!

The position, appearance, and precise meaning of work safety labels on the machine is determined in the following tables (Tab. 3) and in the figure (Fig. 1).

Table 3 – Self-adhesive warning safety labels located on the cultivator

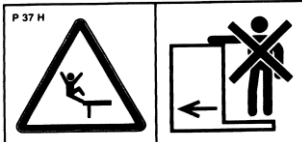
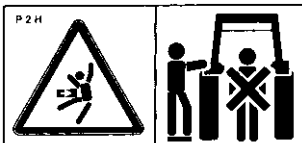
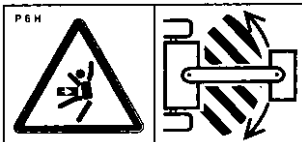
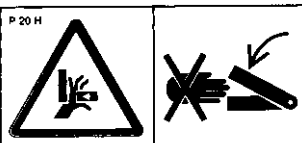
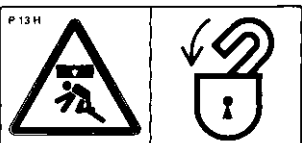
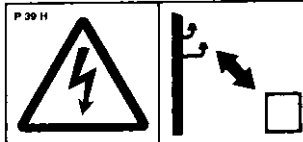
WARNING SAFETY LABEL	LABEL TEXT	MACHINE POSITION
	<p>Before handling the machine, carefully read the operating manual. Observe the instructions and safety regulations for machine operation during use.</p>	<p>P 1 H</p>
	<p>Travelling and transport on the machine structure is strictly forbidden.</p>	<p>P 37 H</p>
	<p>When connecting or disconnecting, do not step between the tractor and the machine, also do not enter this space, if the tractor and the machine are not at rest and the engine is not turned off.</p>	<p>P 2 H</p>
	<p>Stay outside the reach of the tractor - agricultural machine set, if the tractor engine is in operation.</p>	<p>P 6 H</p>
	<p>When folding the side frames, do not reach into the space of the machine folding joints. There is a danger of cutting when setting the depth of the machine.</p>	<p>P 20 H</p>
	<p>Before commencing the machine transport, secure the axle with spherical valves against unexpected drop.</p>	<p>P 13 H</p>
	<p>When working and transporting the machine, maintain safe distance from the electric appliances.</p>	<p>P 39 H</p>

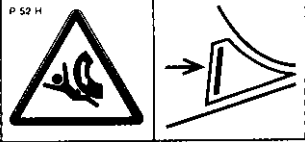
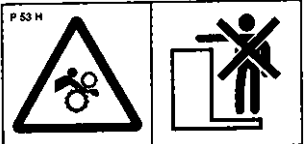
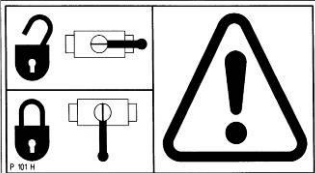
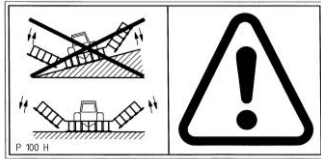
	<p>Secure the machine against unwanted movement by positioning on its working bodies.</p>	<p>P 52 H</p>
	<p>Stay outside the reach of the tractor - agricultural machine set, if the tractor engine is in operation.</p>	<p>P 53 H</p>
	<p>The shown positions of the lever and the function of the hydraulic spherical valve located on the piston rod.</p>	<p>P 101 H</p>
	<p>Before commencing the machine transport, secure the axle with spherical valves against unexpected drop.</p>	<p>P 100 H</p>

LOCATION OF SAFETY LABELS ON THE MACHINE

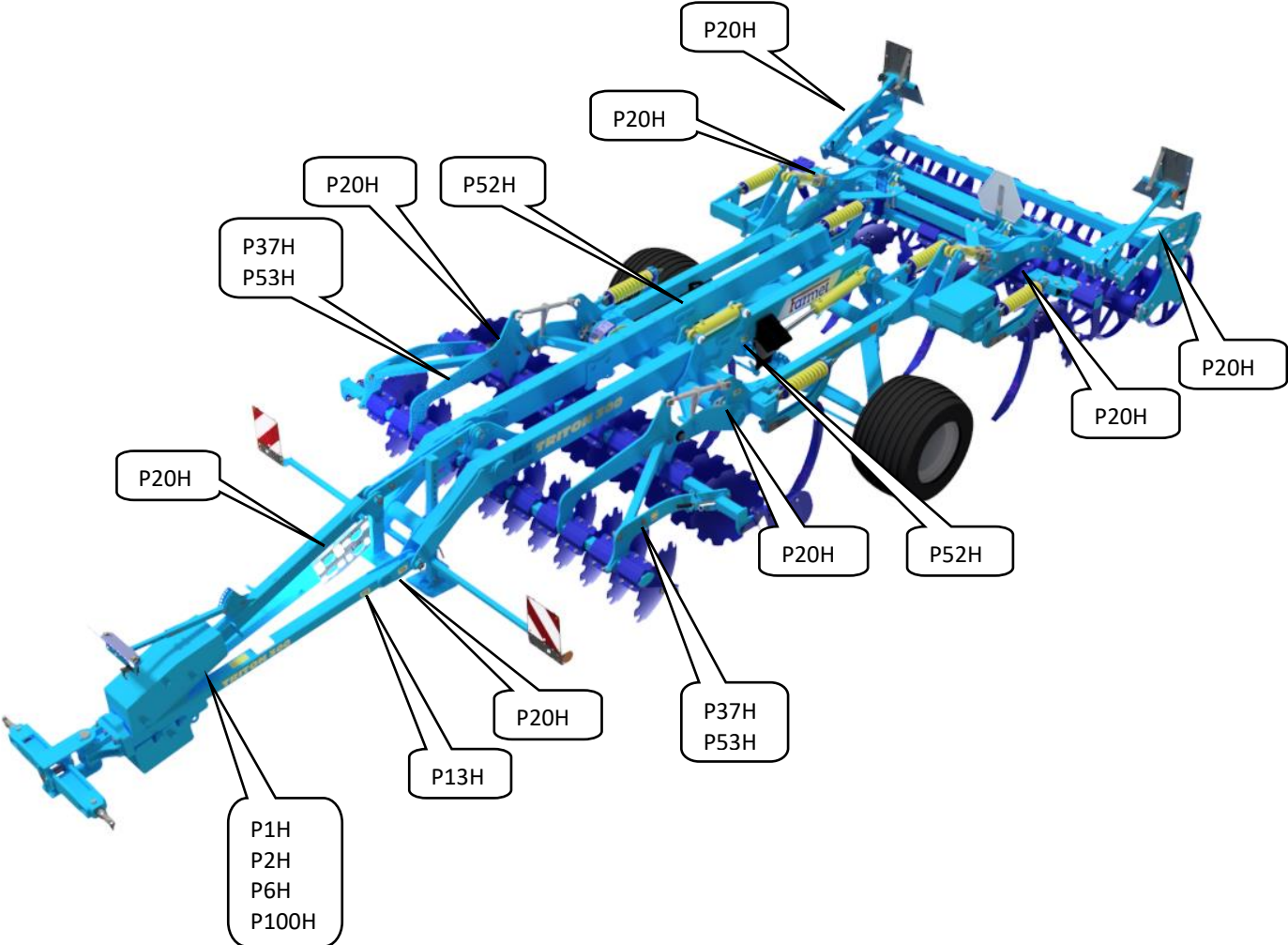

1. DESCRIPTION

The **TRITON 300 P** machine is designed as semi-carried and not folding. The basic version consists of the drawbar, which connects to the pulling vehicle according to the corresponding equipment. Then, there is a central frame with the transport axle and the working section frames. The discs are mounted in two rows on the front part of the central frame. The disc rows are followed with two rows of shares with automatic spring protection. There is a row of levelling discs after the second share row that levels the soil. The last part of the machine consists of rollers that compact the aerated soil.

Basic technological specification of the machine:

- ✓ All-area stubble cultivation after harvest with intense mixing effect
- ✓ Processing soil up to a depth of 35 cm, tillage replacement
- ✓ Excellent incorporation of crop residue into soil.

1.1 MACHINE SECTION ARRANGEMENT

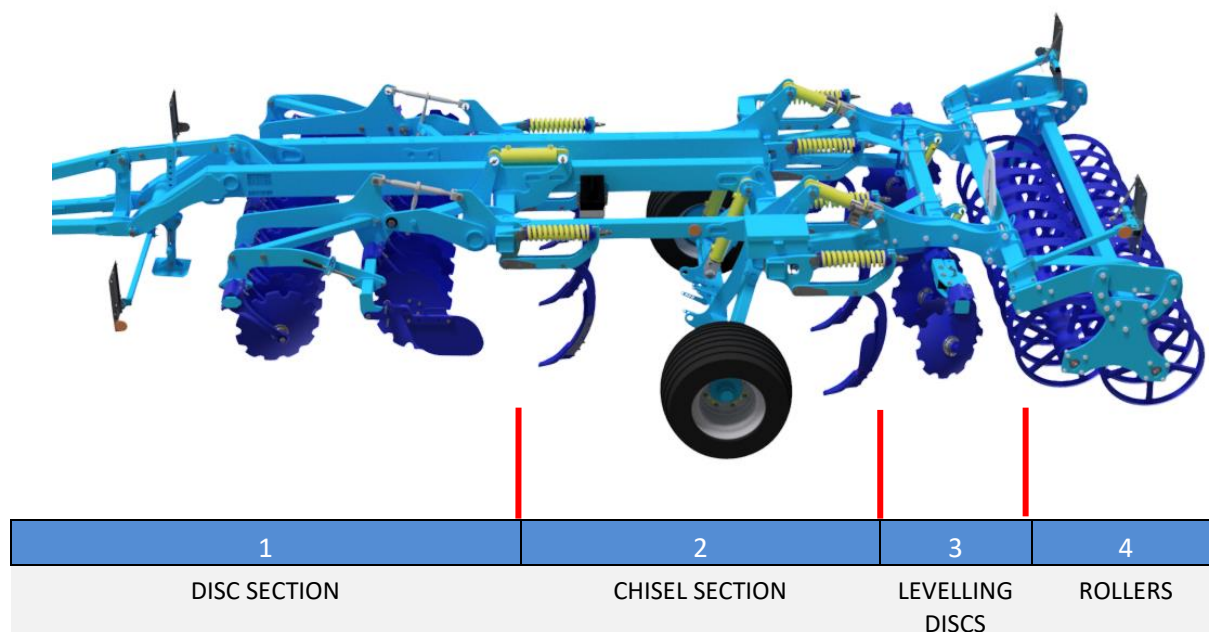

1.2 Working parts

Disk working unit

- Disk diameter 510 (560) mm
- Maintenance-free flexible bearing
- Forged peel



Share working unit

- The basic setting of the securing spring (X) is performed by the manufacturer at 395 ± 5 mm ($15,56 \pm 0,20$ in) so it is horizontal.
- Regularly check the nut tightening of the lower and the upper pivot of the securing, tighten as needed.
- Regularly check the nut tightening of the securing rod.

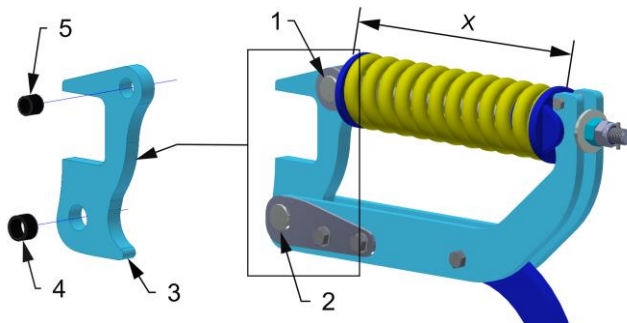

- 1- Upper pivot
- 2- Lower pivot
- 3- Safety back stop
- 4- Lower hardened case
- 5- Upper hardened case

SHARES

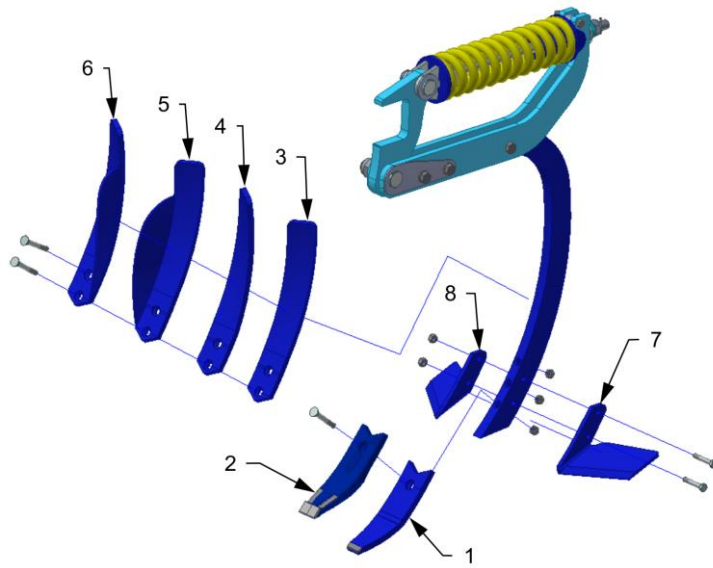

- 1 – Chisel SK
- 2 – Chisel MULTICARBIDE
- 3 – Share top, left
- 4 – Share top, right
- 5 – Share top, left, with a deflector
- 6 – Share top, right, with a deflector
- 7 – Left wing
- 8 – Right wing

2. HYDRAULICS

SHUT-OFF (BALL) VALVE FUNCTION AND POSITION

- Shut-off (ball) valves are used in the machine: a separate valve for the drawbar piston-rod and a set of valves set up in a combination with the control levers on a well-arranged panel.

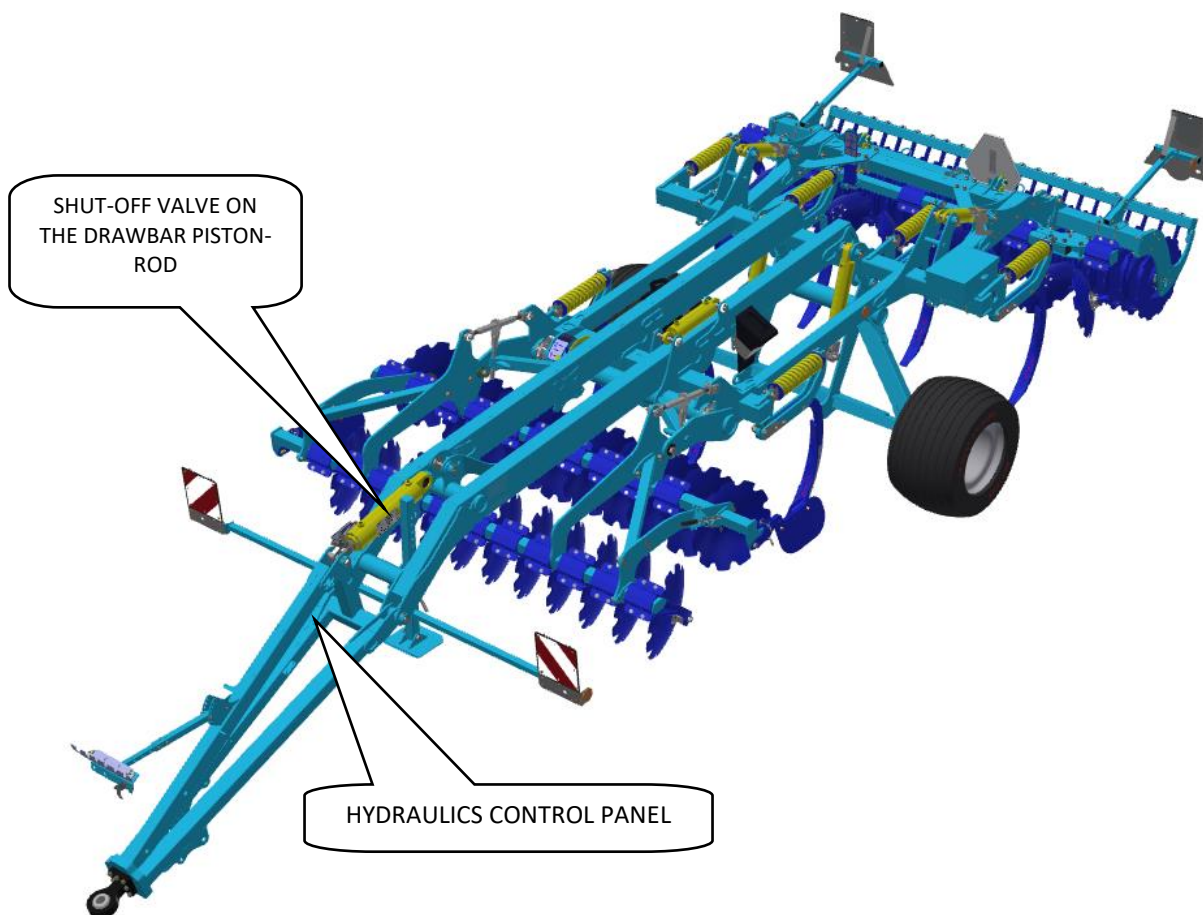

Shut-off valve on the drawbar piston-rod

- The shut-off valve of the drawbar piston-rod can be used when it is required to control the axle without moving the drawbar piston-rod at the same time.

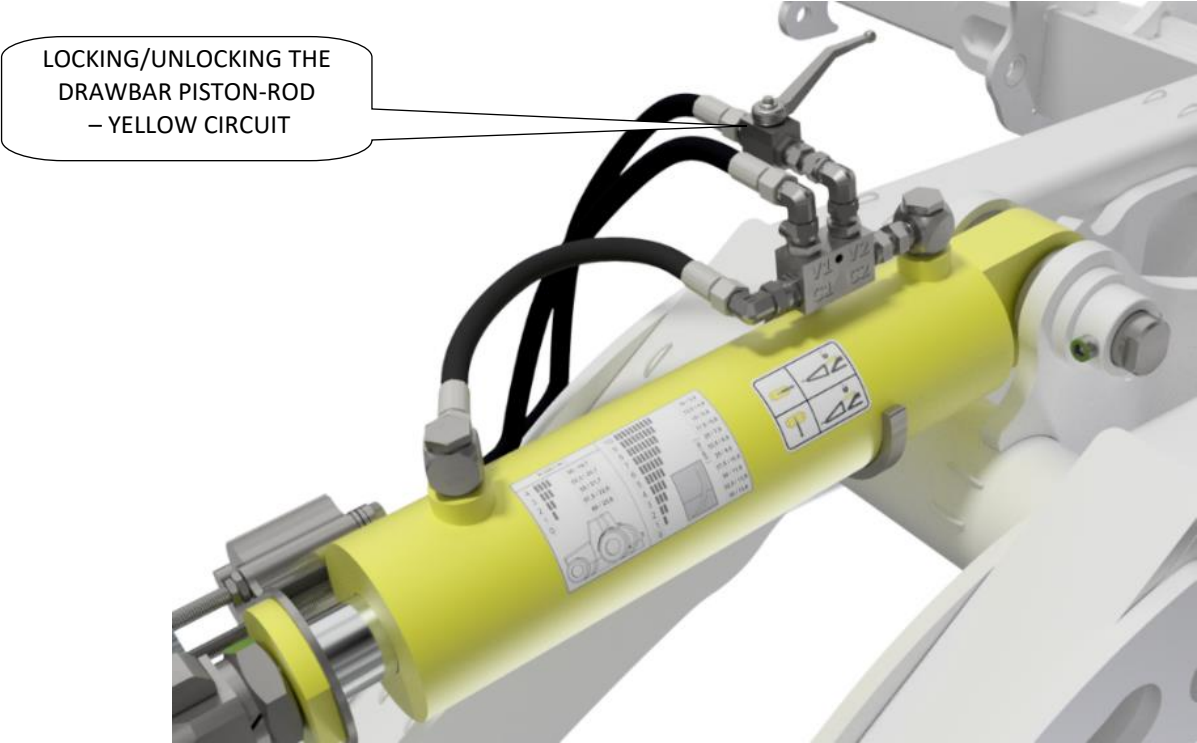

Hydraulics control panel with 3 levers**

*The equipment variant with a three-point hitch connection device does not include a drawbar piston rod.

**The number of levers depends on the range of equipment of the machine.

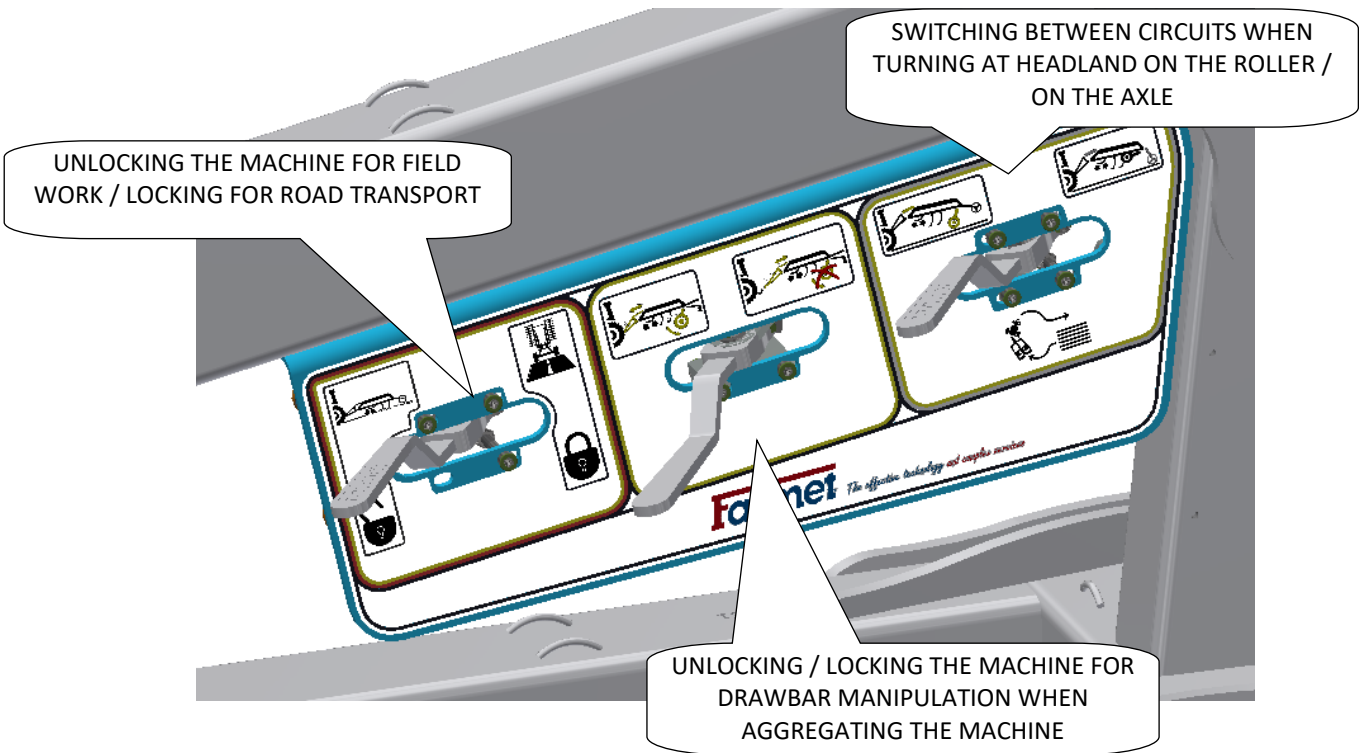

2.1 DESCRIPTION OF MACHINE HYDRAULICS

- When disconnecting the quick-couplers, both valves on the drawbar must be closed in the same way as for road transportation.
- Connect the hydraulics only when the hydraulic circuits of the machine and the tractor (aggregate) are in a pressure-less condition.
- The hydraulic system is under high pressure. Regularly check for leaks and immediately remove obvious damage of all lines, hoses, and pipe unions.
- When seeking and removing leaks, use only the suitable tools.
- For connecting the hydraulic system of the machine to the tractor, use the plug (on the machine) and the socket (on the tractor) of the quick-couplers of the same type. Connect the quick-couplers of the machine to the hydraulic circuits of the tractor so that the **YELLOW DUST CAPS** for lifting the machine on the axle are on one control circuit, the **GREEN DUST CAPS** for setting the front disc section are on the second control circuit, the **BLUE DUST CAPS** for controlling the rear packer discs are on the third control circuit, and the **WHITE DUST CAPS** for controlling the setting of the working depth of the machine on the rollers is on the fourth control circuit.



In order to prevent accidental or foreign person (children, passengers) caused movement of the hydraulics, the control switchboards on the tractor must be secured or blocked in the transport position.

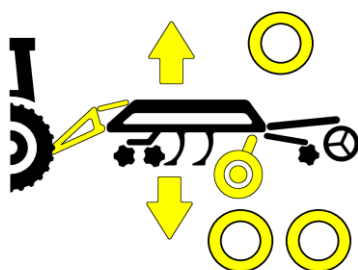

YELLOW DUST CAPS – controlling the transport axle

- 1 STRAP – lifting the machine into the transport position, i.e. axle is lowered down
- 2 STRAPS – the machine is lowered to the working position, i.e. the axle is lifted up from the ground

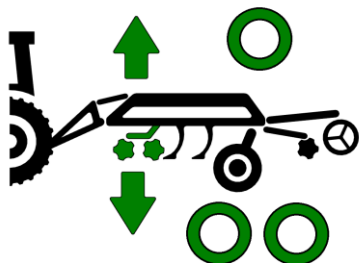

GREEN DUST CAPS – controlling the position of the front disc section

- 1 STRAP – lifting the front disc section
- 2 STRAPS – lowering the front disc section

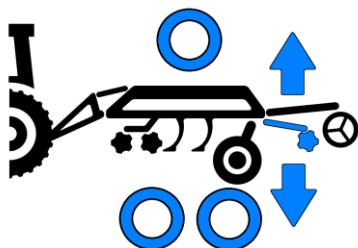

BLUE DUST CAPS – controlling the position of the rear packer discs (supporting legs – when included)

- 1 STRAP – lifting the packer discs
- 2 STRAPS – recessing the packer discs

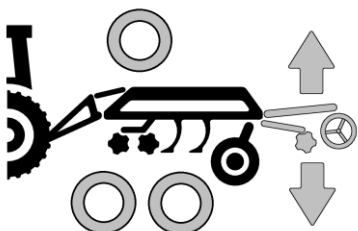

WHITE DUST CAPS – setting the depth

- 1 STRAP – lifting the rollers (increasing the working depth)
- 2 STRAPS – lowering the rollers (decreasing the working depth)



Parts of the hydraulic system of the machine, which are under pressure, are forbidden to disassemble. Hydraulic oil that penetrates the skin under high pressure causes severe injuries. In case of injury, seek a physician immediately.

2.2 USING THE HYDRAULICS CONTROL PANEL

- There is a control panel with up to 4 levers on the drawbar (the number of levers may differ according to the machine equipment).
- Moving the levers opens or closes the ball valves in the hydraulic circuits.
- The lever positions according to the pictograms below determine the setting of the hydraulic circuits for the required function of the machine.
- The individual levers are also colour-coded for easier orientation of the operator, in accordance with the hydraulic circuits controlled by the corresponding lever.



When driving the machine on road, the lever that locks the machine for transport has to be in the RIGHT position, i.e. locked.

LEVER FOR LOCKING THE MACHINE FOR TRANSPORT

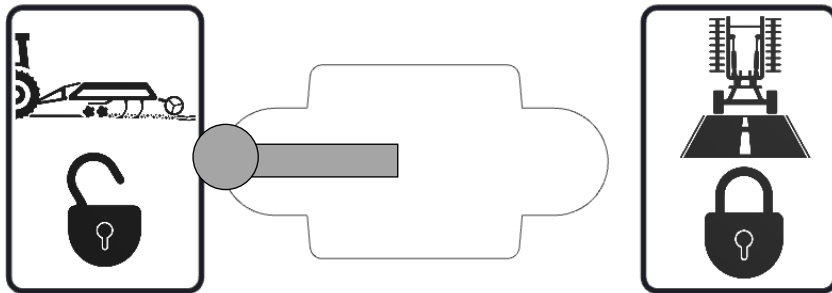

LEFT POSITION

The machine is in the working position. The **YELLOW** circuit of the axle and the drawbar piston-rod are open and the piston-rods can move.

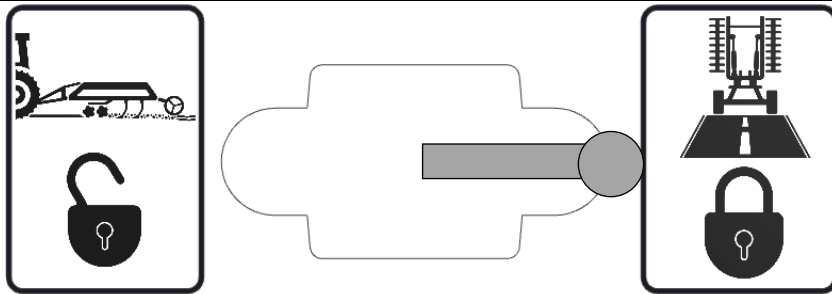

RIGHT POSITION

The machine is in the transport position. The **YELLOW** axle circuit and the drawbar piston-rod are closed.

LEVER FOR TURNING AT HEADLAND *

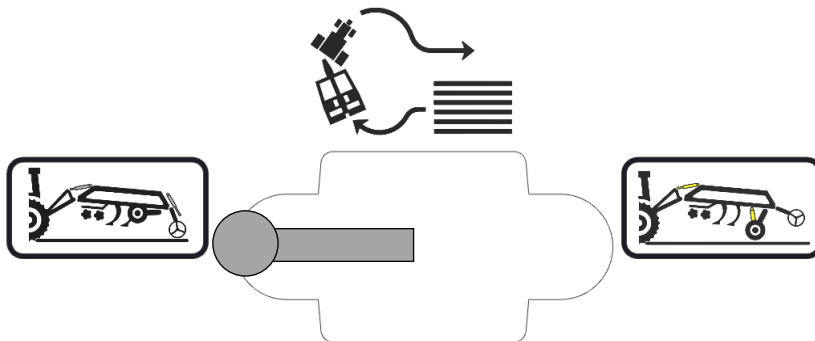

LEFT POSITION

The machine is set to turning on the rear roller (WHITE circuit). The drawbar piston-rod is also controlled by the WHITE circuit when the axle is lifted.

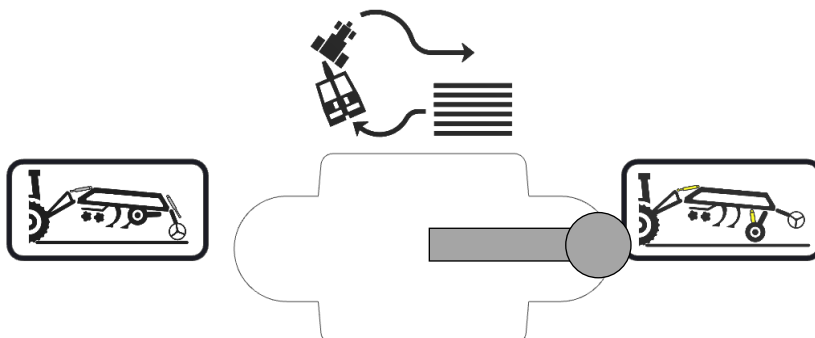

RIGHT POSITION

The machine is set for turning on the transport axle (**YELLOW** circuit). The drawbar piston-rod is also controlled by the **YELLOW** circuit when the axle is lifted.

**The drawbar needs to be lifted by the tractor shoulders when the machine is not equipped with the drawbar piston-rods with a Cat. 3 three-point hitch.*

LEVER FOR SWITCHING ADDITIONAL TOOLS **

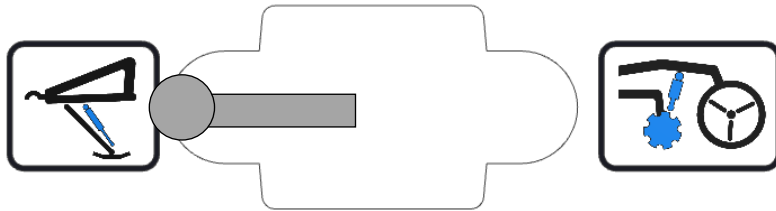

LEFT POSITION

The **BLUE** circuit is set to control the supporting leg.

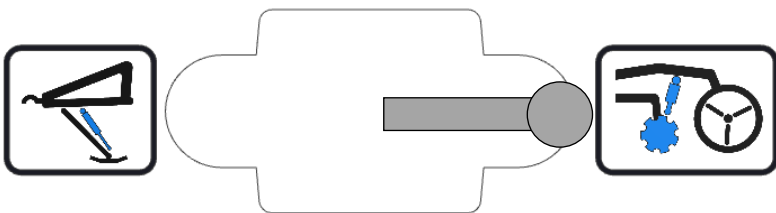

RIGHT POSITION

The **BLUE** circuit is set to control the lifting of the levelling discs.

***Applies in the case when the machine is equipped with a hydraulic supporting leg. In the basic version, the supporting leg is pulled out manually and the blue circuit is connected directly to control the levelling discs.*

LEVER FOR SETTING THE MACHINE FOR AGGREGATION

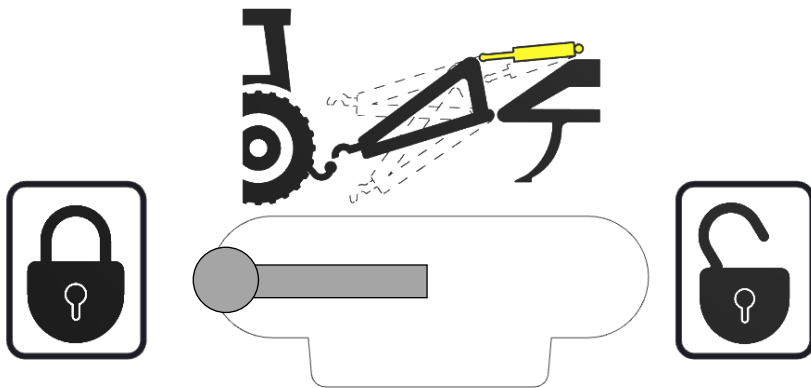

LEFT POSITION

The **YELLOW** circuit is set in the initial condition, i.e., both the axle and the drawbar piston-rod are controlled at the same time.

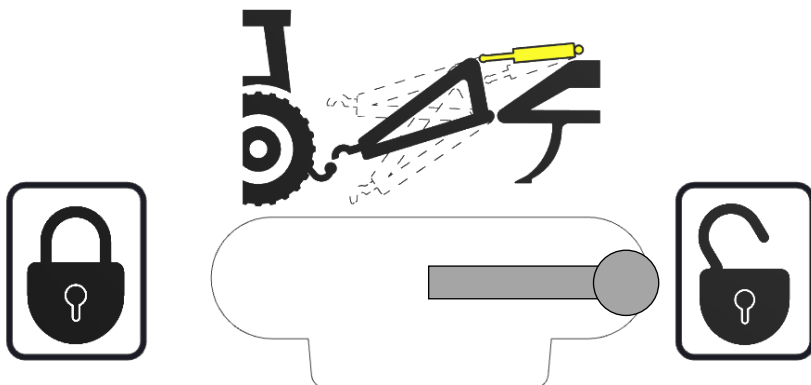

RIGHT POSITION

The **YELLOW** circuit is set for machine aggregation, i.e., the axle does not move, only the drawbar piston-rod does. The operator is thus able to adjust the height of the hitch as needed during the aggregation of the machine to the pulling vehicle.

3. MACHINE ASSEMBLY AT THE CUSTOMER

- The operator must perform the assembly according to the instructions of the producer, best in cooperation with the expert servicing technician determined by the producer.



- The operator must secure a functional test of all assembled parts after the completion of the machine assembly.
- The operator must secure that the handling of the machine using lifting equipment during its assembly is in accordance with chapter „C“.

4. COMMISSIONING

- Before taking over the machine, test and check, whether damage occurred during transport and whether all parts contained in the bill of delivery were supplied.



- Before commissioning the machine, carefully read this operating manual, especially Chapters **A-D**. Before the first use of the machine, familiarise yourselves with its controls and overall function.
- During work with the machine, observe not only the instructions of this operating manual but also generally valid regulations of work safety, health protection, fire and transport safety, and environmental protection.
- The operator must check the machine before every use (commissioning) from the standpoint of completeness, work safety, work hygiene, fire safety, transport safety, and environmental protection. A machine showing signs of damage must not be commissioned.
- Aggregation of the machine with the tractor is to be performed on a flat and hardened surface.
- When working on slopes, observe the lowest slope grade of the set **TRACTOR - MACHINE**.
- Before starting the tractor motor, check whether no person or animal is in the working space of the set and push the warning sound signal.
- The operator is responsible for the safety and all damage caused by the operation of the tractor and the connected machine.
- The operator is obliged to adhere to the technical and safety regulations of the machine determined by the producer when working.
- The operator is obliged to retract the working bodies of the machine from the ground when turning at the headland.
- The operator is obliged to observe the prescribed working depths and speeds stated in the manual in Tabl.2 when working with the machine.
- The operator is obliged to lower the machine to the ground and secure the set against movement before leaving the tractor cabin.

5. AGGREGATION TO A TRACTOR

- The machine can be connected only to a tractor, whose curb weight is identical or higher than the overall weight of the connected machine.
- The machine operator must observe all generally valid regulations of work safety, health protection, fire safety, and environmental protection.
- The operator may connect the machine exclusively to a tractor that is equipped with a rear three-point suspension and a functional undamaged hydraulic system.
- It is possible to use the transport axle with the valve on the drawbar piston rod closed to set the height of the drawbar.
- The table of requirements for the towing means for work with the machine:

Requirement for the tractor engine power for cultivator TRITON 300 P		150-235 kW
Requirement for the bottom hitch	Bottom hitch	C 50 C 70 K 80 TPS cat. 3
Requirement for the tractor's hydraulic system	Rear roller depth setting circuit	Circuit pressure 200 bar, 2 pcs of quick-coupler sockets ISO 12,5
	Axle lifting circuit	Circuit pressure 200 bar, 2 pcs of quick-coupler sockets ISO 12,5
	Levelling disc circuit (supporting legs)	Circuit pressure 200 bar, 2 pcs of quick-coupler sockets ISO 12,5
	Circuit for lifting the front disc section	Circuit pressure 200 bar, 2 pcs of quick-coupler sockets ISO 12,5



When connecting, no persons may stay in the space between the tractor and the machine.

HYDRAULIC OIL SPECIFICATIONS

The hydraulic circuit of the machine is filled with oil at the factory:

Performance level: API GL 5; SAE 10W-30; SAE 80
 Manufacturer's specification: ALLISON C4; CATERPILLAR TO-4; VOLVO VCE WB 101; 97303 JONH DEERE 20C/20D
 ZF TE-ML 03E/05F/06E/06F/06K/17E/21F; PARKER
 DENISON HF-0/HF-1/HF-2 New HOLLAND NH 420A/410B MASSEY FERGUSON M1135/M1141/M1143/ M1145
 KUBOTA UDT Fluid CASE IH MS-1204/MS-1206/ MS-1207/MS-1209 FORD M2C134D M2C86B/C CNH MAT 3525/ MAT3526 SPERRY VICKERS/EATON
 M2950S, I-280-S SAUER
 SUNDSTRAND(DANFOSS) Hydro Static Trans fluid; CASE CNH MAT 3540(CVT), Claas(CVT), AGCO CVT; ML200,
 Valtra G2-10(XT-60+)

6. MACHINE TRANSPORT ON ROADS



Transport position of **TRITON 300 P**

- Connect the machine by attaching it to the tractor.
- Lift the machine up on the axle, move the lever for locking the machine on the hydraulics control panel into the locked position for transport.
- The machine must be equipped with removable shields with marking of contours, functional lighting, and the board of the rear marking for slow vehicles (according to ECE No. 69).
- The lighting must be activated during travelling on roads.
- The tractor must be equipped with a special light device of an orange colour, which must be activated during travelling on roads.
- The maximum transport speed during travelling on roads is **30 kph**.



Checking the nuts on the transport axle

- Use the plastic arrow “Check Point” to check for loose nuts. It promptly shows the condition of the nuts, whether they are loose or not.
- Always check the Check Points before driving.
- When the arrows are not facing one another, the nuts have to be tightened to the required torque and the Check Point arrows have to point against one another as shown in the green picture.

Torque for the axle nuts:

M18x1,5 - 265Nm

M20x1,5 - 343Nm

M22x1,5 - 440Nm

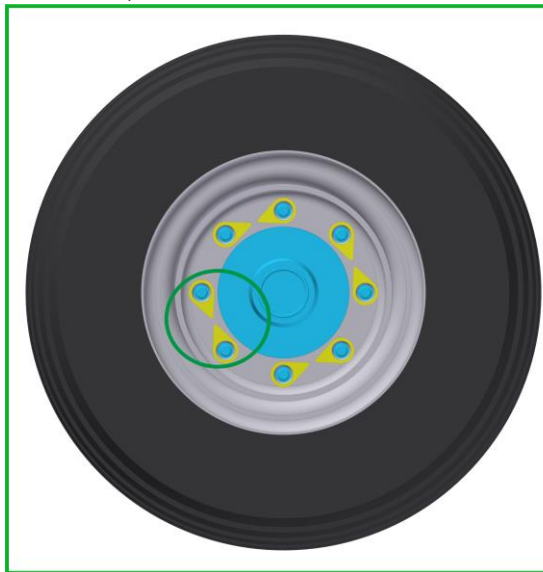

INITIAL POINT-TO-POINT CONFIGURATION

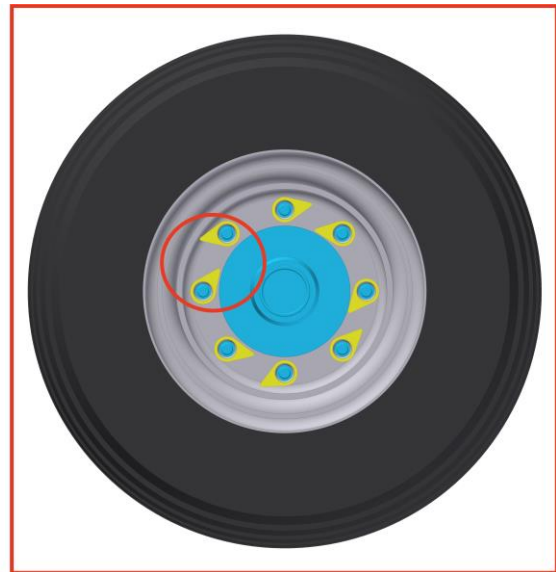

DANGER – WHEEL NUTS HAVE LOOSENED!



Ban of transport with decreased visibility!

- Bring the machine into the transport position.
- The operator is obliged to pay increased attention during transport on roads, due to the transport dimensions of the machine.
- The operator must observe the valid regulations for transport on roads (laws, decrees) after connecting the machine to the tractor, for reason of a change of the axle load. The driving properties of the set also change depending on the terrain nature, adapt the manner of driving to these conditions.
- The operator is obliged to present the machine certificate of roadworthiness as needed, according to the valid regulations for road traffic (decree, law) (only in the Czech Republic).
- The operator is obliged to secure sufficient outlook during reversing from his position of the tractor driver. In case of insufficient outlook, the operator is obliged to call a competent and informed person.
- During machine transport on roads, the operator must observe the valid laws and decrees that deal with this topic and which specify the relationships of the tractor axle load depending on transport speed.

6.1 SCHARP MACHINE PROJECTION



- The machine contains sharp structural projections
- **It is prohibited to operate and transport the machine on roads when visibility is reduced!!** - Persons or objects, or other road traffic participants could get caught.
- **The machine operator must be extra cautious when driving on roads and consider the width of the machine and safe distance from persons, vehicles and objects, or other road traffic participants!!**

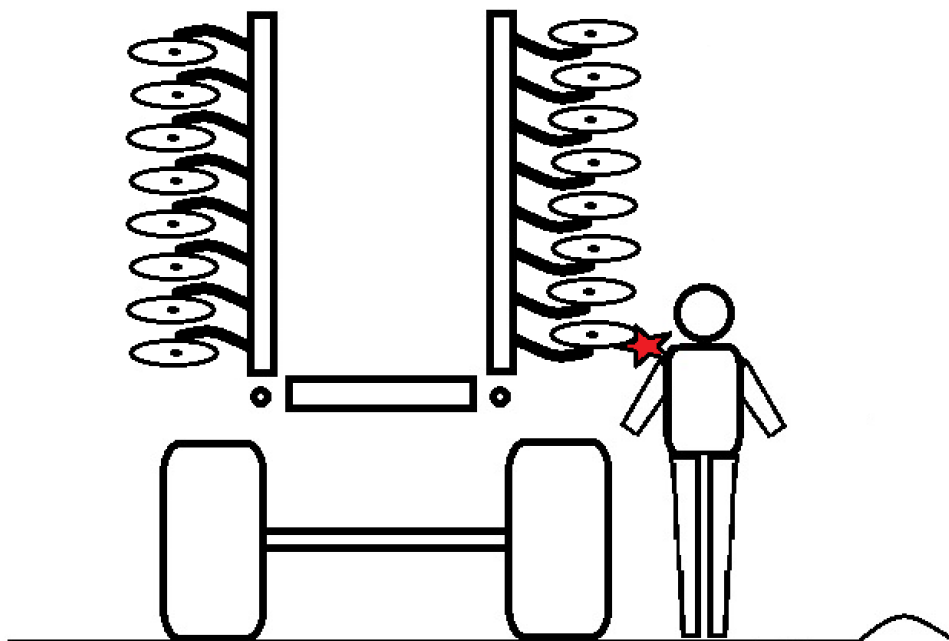
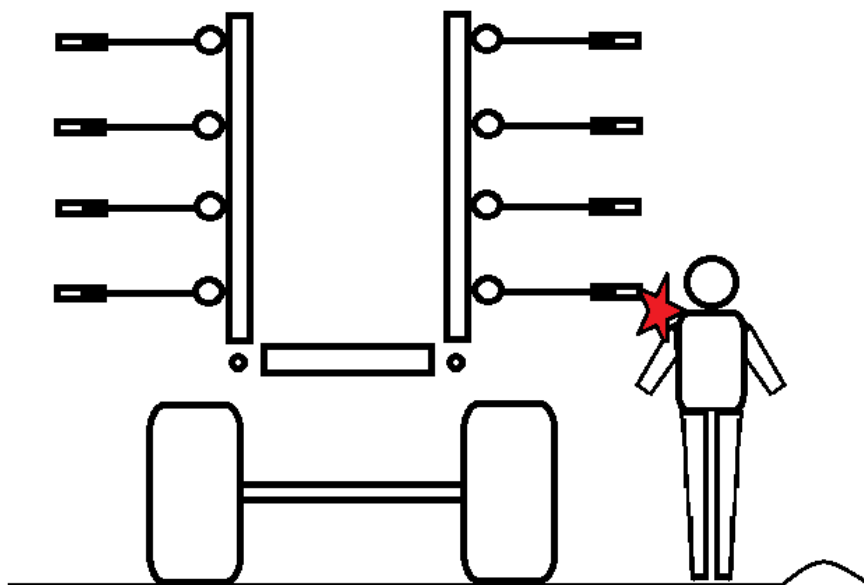

7. MACHINE ADJUSTMENT

7.1 WORKING DEPTH ADJUSTMENT

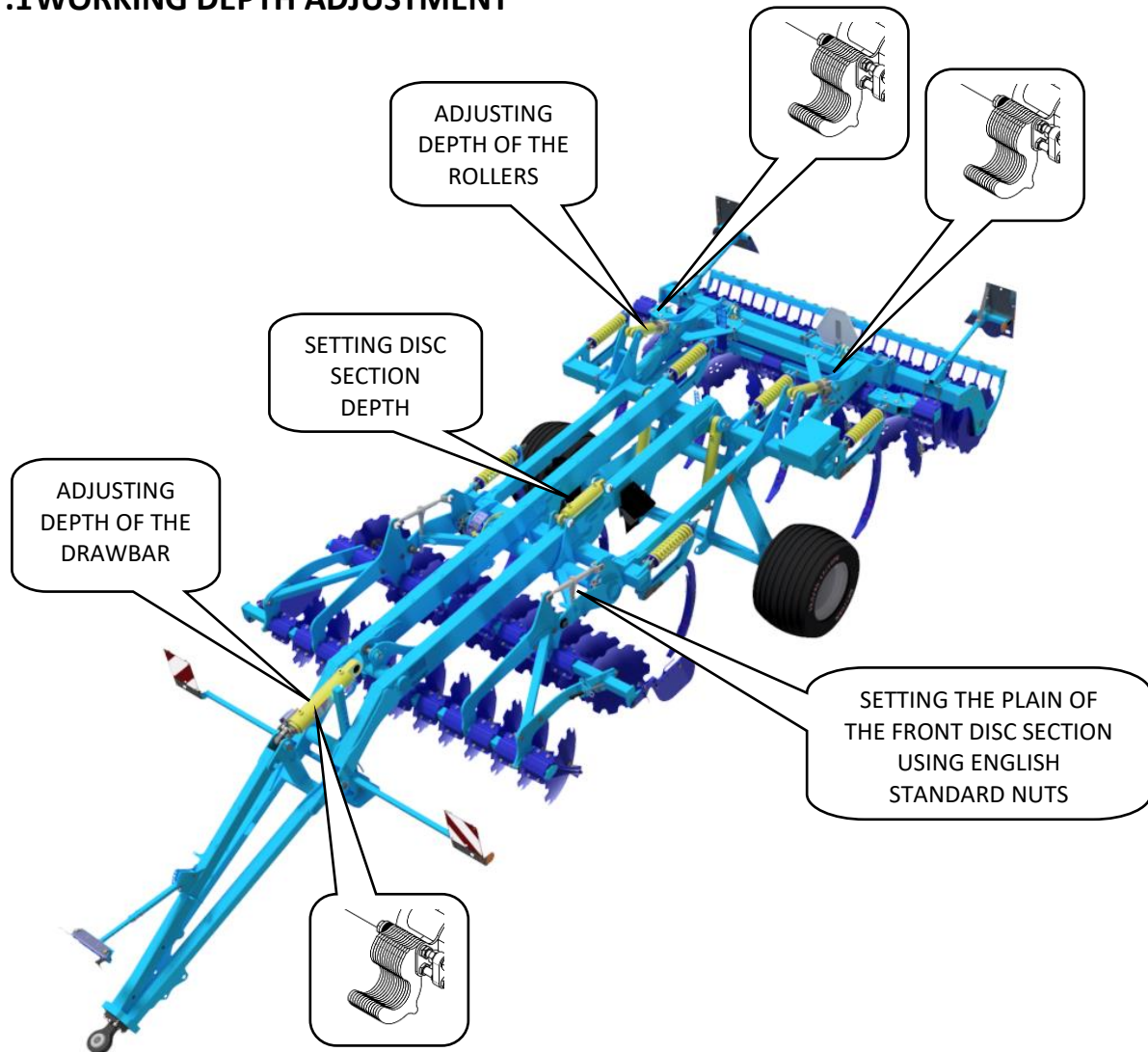

Setting the working depth of the chisels

- The working depth of the chisels is set by adjusting the machine frame height above the ground.
- In the front of the machine, the depth is set on the drawbar.
- In the rear of the machine, the depth is set on the rollers.
- The machine frame must be parallel to the ground.
- The adjustment is done by changing the number of the space washers on the piston-rods.
- The table states the individual working positions and the number of space washers needed to achieve the required machine depth.
- The stated working depths of the individual positions are for information only. They might differ according to the individual soil conditions. It is possible to add or remove a required number of space washers as needed.
- The working depth of the machine must be set so that the spring protection of the working tools (tines) does not unlock frequently. The spring protection should only release very sporadically. Unlocking can occur on a maximum of one working tool (tine) on the entire machine after a 100 - 200 m drive. If unlocking is more frequent, it is necessary to reduce the working depth or use narrow chisels. Due to the frequent release of the spring protection, excessive wear of the pins and other parts of the spring protection can occur. In this case, their more frequent replacement is necessary.



The number of the space washers must be the same on all piston-rods!!!

17		2 / 0,8
16		4 / 1,6
15		6 / 2,4
14		8 / 3,1
13		10 / 3,9
12		12 / 4,7
11		14 / 5,5
10		16 / 6,1
9		18 / 6,9
8		20 / 7,7
7		22 / 8,5
6		24 / 9,3
5		25 / 9,8
4		27 / 10,6
3		29 / 11,4
2		31 / 12,2
1		33 / 13,0
0		35 / 13,8

[cm/in]

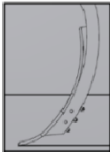

Adjustment according to the tractor hitch

- The number of space washers on the drawbar piston-rod must be adjusted according to the height of the tractor hitch above the ground.
- The number of space washers must be increased by the number provided in the following table.
- The number of space washers can be modified to achieve parallelism of the frame with the ground.

h [cm / in]					
4		50 / 19,7	13		2,5 / 1,0
3		52,5 / 20,7	12		5 / 2,0
2		55 / 21,7	11		7,5 / 3,0
1		57,5 / 22,6	10		10 / 3,9
0		60 / 23,6	9		12,5 / 4,9
			8		15 / 5,9
			7		17,5 / 6,9
			6		20 / 7,9
			5		22,5 / 8,9
			4		25 / 9,8
			3		27,5 / 10,8
			2		30 / 11,8
			1		32,5 / 12,8
			0		35 / 13,8

[cm / in]

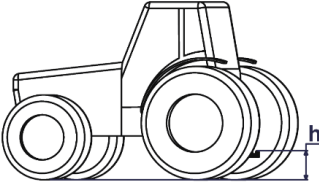
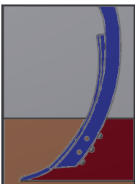
Setting the working depth of the front disc section

- The working depth of the disc section depends on the set depth of the chisels.
- The setting range for the front disc section is 330 mm so that it is possible to cover the range of the working depth of the discs from 50 to 120 mm for all the working depths of the chisel section.
- The working depth of the discs must never exceed 120 mm.
- The difference in the working depth between the disc and chisel sections is set hydraulically (GREEN circuit).
- The position of the disc section can be seen on the indicator (1 – minimum depth, 3 – maximum depth).
- The indicator position can be adjusted by turning the strap with the scale.

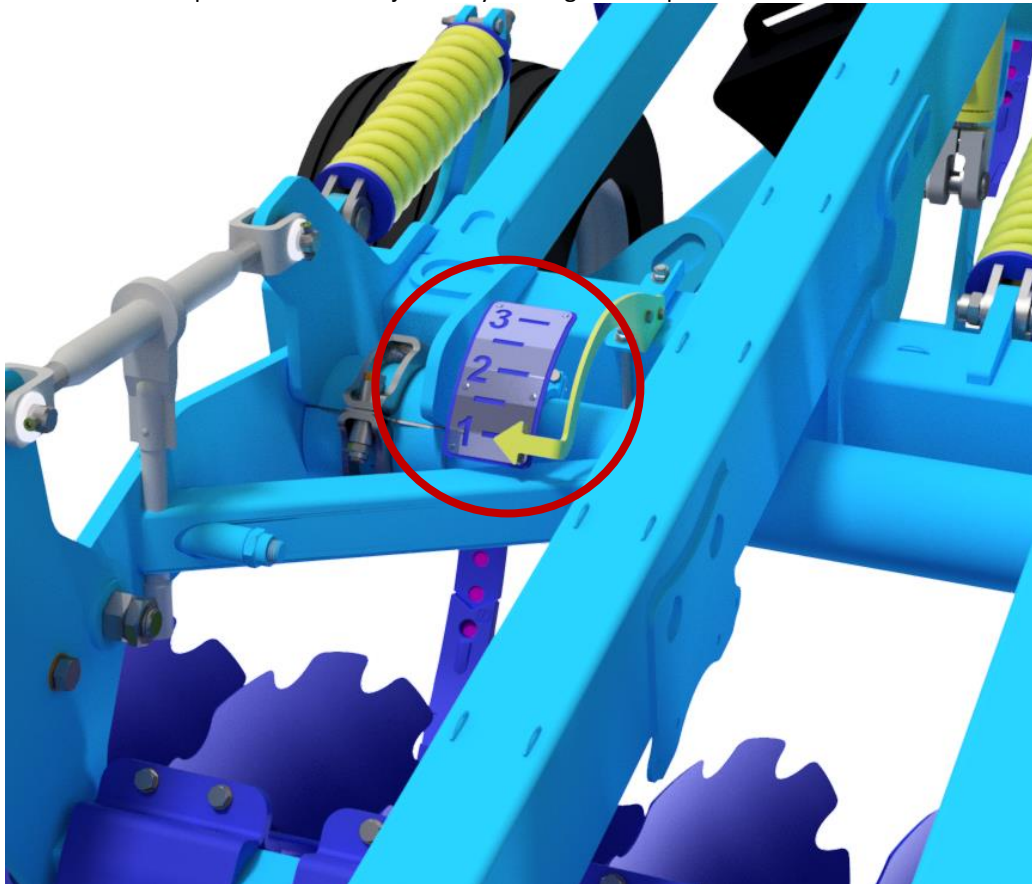

Setting parallelism of the disc section with the ground

- The setting is done using English standard nuts.
- The setting does not change when the working depth changes.
- The English standard nuts have to be set evenly, the length of all nuts has to be identical for operation.
- The section is parallel to the ground when the length of the English standard nut is $L = 550$ mm.

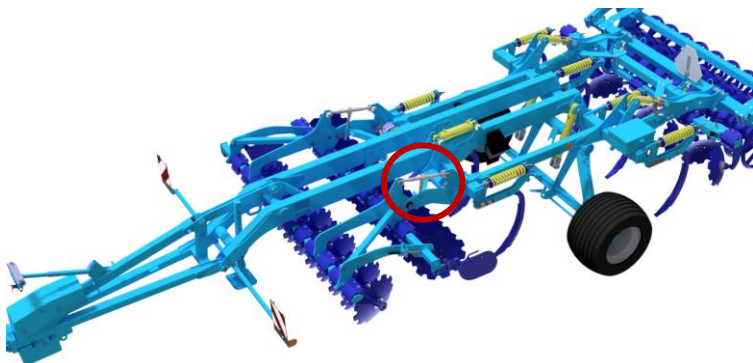

7.2 ADJUSTING THE LEVELLING DISCS

The depth of the levelling discs is set using the hydraulic circuit (BLUE). Be careful when performing the adjustment.

The height setting of the levelling discs can be checked on the indicator as shown in the picture (1 – minimum depth, 3 – maximum depth).

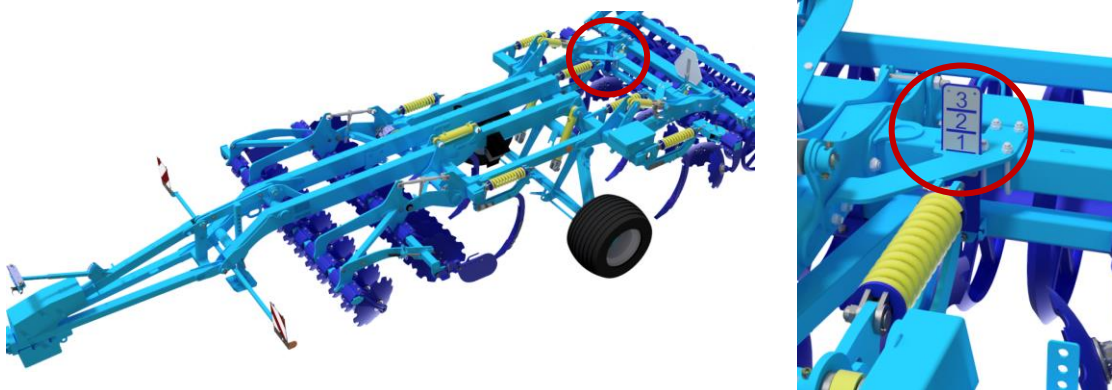

Correctly set discs provide perfect levelling and covering with fine soil along the entire width. When the discs are recessed too low, there are grooves behind the rear shares; when the discs are recessed too deep, there are tracks of collected soil behind the machine. Check the correct disc setting during work – the setting may differ according to the soil conditions and the wear of the discs.

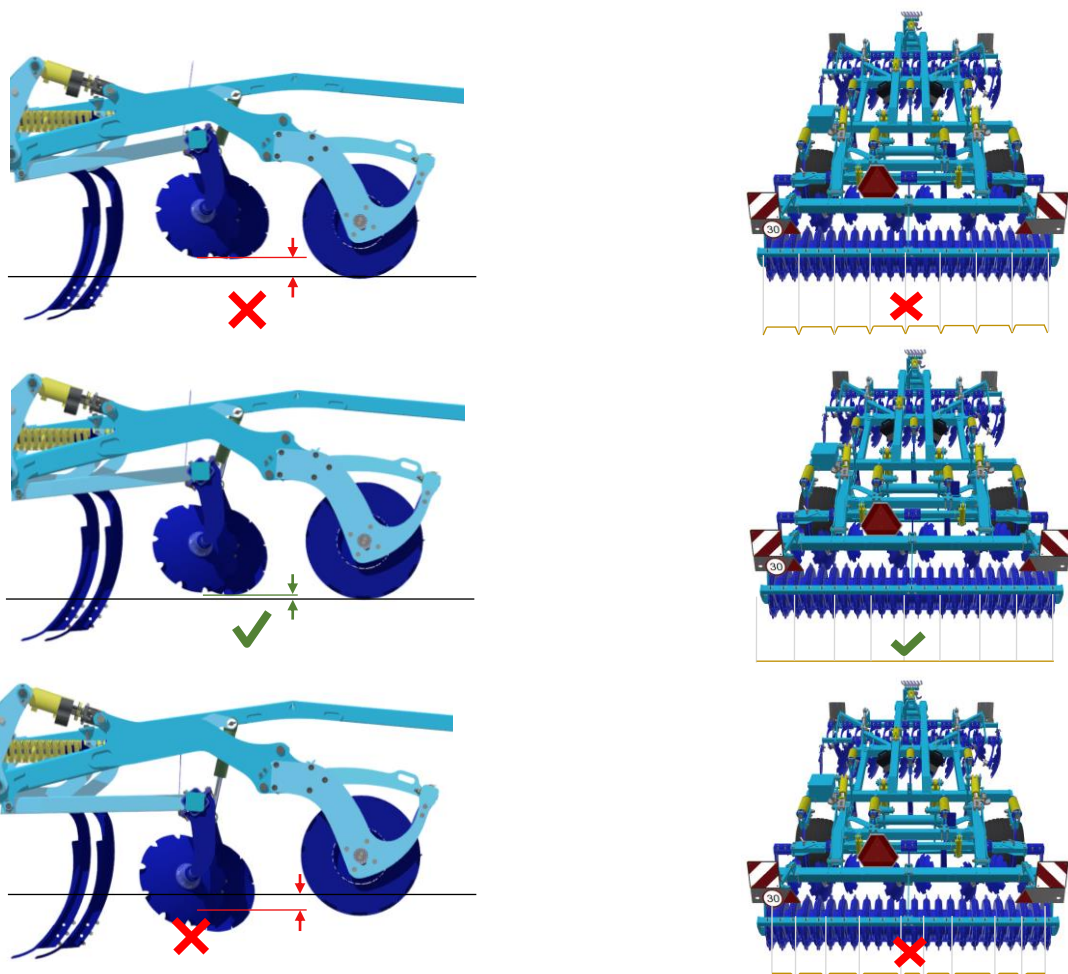

8. MACHINE MAINTENANCE AND REPAIRS



Observe the safety instructions for treatment and maintenance.



- If it is necessary to weld during the repair and have the machine connected to the tractor, it must have disconnected supply cables from the alternator and the accumulator.
- Check the tightening of all screw and other assembly connections at the machine before every use of the machine, furthermore continuously as needed.
- Continuously check the wear of the working bodies of the machine, possibly replace these worn working bodies with new ones.
- Adjustment, cleaning, and lubrication of the machine may only be performed with the machine at rest (i.e. the machine is standing and not working).
- When working on a lifted machine, use suitable support equipment supported at marked points or at points suitable for that.
- During adjustment, cleaning, maintenance, and repair of the machine, you must secure those parts of the machine that could endanger the operator by falling or another movement.
- For catching the machine during handling using lifting equipment, use only the places marked with self-adhesive labels with the chain sign "—○—".
- Upon a failure or damage of the machine, immediately turn off the tractor's engine and secure against restarting, secure the machine against movement ⇒ only then you can remove the failure.
- During repairs of the machine, use exclusively the genuine spare parts, suitable tools and protective equipment.
- Regularly check the prescribed pressure in the machine tyres and the condition of the tyres. Perform possible repairs of the tyres in an expert workshop.
- Check the indicator of loose nuts, "Check Point", regularly according to the instructions.
- Keep the machine clean.



Do not clean hydraulic cylinders and bearings with a high-pressure cleaner or direct water stream. The seals and bearings are not watertight at high pressure.

MAINTENANCE PLAN

Perform the planned maintenance according to the instructions:

Maintenance Task	Daily (season)	Once a week	Before season	After season	Time interval
Machine in general					
<ul style="list-style-type: none"> • Visual inspection of the machine • Checking for any undesirable sounds, vibrations and excessive wear 	X				
<ul style="list-style-type: none"> • Checking crucial nodes: pins, bearings, rollers, working parts 	X		X	X	
<ul style="list-style-type: none"> • Machine cleaning • Storing the machine under roof, if possible • Recording the mileage of the machine/season (ha) 		X		X	
<ul style="list-style-type: none"> • Comprehensive inspection • Checking the frame 	X			X	
<div style="display: flex; align-items: center;">  <p>Do not use a high-pressure cleaner or direct stream of water to clean the hydraulic rollers, bearings, electric and electronic parts. The seals and bearings are not waterproof at high pressure.</p> </div>					
Hydraulic system					
Checking the function, tightness, mounting and worn spots of all hydraulic parts and hoses		X	X		
Hydraulic hoses – replacement: <ul style="list-style-type: none"> • Damaged external casing of the hose (mechanically or blistered) • Fluid seepage (especially the end piece) • Bumps or blisters on the hose • Deformed or corroded end piece • Loose end piece – the hose spins 	X			X	
Hydraulic hoses - replacement: <ul style="list-style-type: none"> • Expired service life of the hose <div style="display: flex; justify-content: space-around; margin-top: 10px;">   </div>					6 years
<p>!!! PREVENTION means removing the problem according to the plan, outside the season, without stress and comfortably before a secondary problem, an accident or a health hazard arises.</p>					

MAINTENANCE PLAN

Perform the planned maintenance according to the instructions:

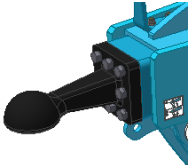
Maintenance Task	Daily (season)	Once a week	Before season	After season	Time interval						
Bolt connections											
Visual inspection of bolt and hydraulic joints, tighten any loose joints using a corresponding torque (see the torque chart)	X			X							
Towing lug – check, tighten if needed  <table border="1" style="margin-left: 20px;"> <tr> <td>M16 - 10.9.</td> <td>300 Nm</td> </tr> <tr> <td>M20 - 10.9.</td> <td>560 Nm</td> </tr> </table>	M16 - 10.9.	300 Nm	M20 - 10.9.	560 Nm		X	X				
M16 - 10.9.	300 Nm										
M20 - 10.9.	560 Nm										
Wheels – tighten all wheel nuts. <ul style="list-style-type: none"> • First time: after 10 hours of operation • Wheel replacement: after 10 hours of operation <table border="1" style="margin-left: 20px;"> <tr> <td>M 18 x 1.5</td> <td>300 Nm</td> </tr> <tr> <td>M 20 x 1.5</td> <td>400 Nm</td> </tr> <tr> <td>M 22 x 1.5</td> <td>500 Nm</td> </tr> </table>	M 18 x 1.5	300 Nm	M 20 x 1.5	400 Nm	M 22 x 1.5	500 Nm		X	X		
M 18 x 1.5	300 Nm										
M 20 x 1.5	400 Nm										
M 22 x 1.5	500 Nm										
Brake system											
Brake line and hoses – check the function, tightness, mounting and clamping, or breaking	X		X	X							
Brake components – check the function, tightness, mounting	X		X	X							
Air nozzle – drain using the draining valve		X		X							
Draining valve – check the function, clean and replace sealing			X	X							
Pipe filter – clean			X	X							
Brake/parking brake – check the function, escapement setting 25-45mm	X										
Brake lining – check the condition of the brake lining, min. thickness of 3mm				X							
Wheels/axle											
Checking the tyre pressure											
Transport axle	TRITON 300 P	19.0/45-17 pressure 400kPa	X		X						
Transport axle bearings – check and adjust allowance if needed (in the workshop)					X						

MAINTENANCE PLAN

Perform the planned maintenance according to the instructions:

Maintenance Task	Daily (season)	Once a week	Before season	After season	Time interval
Electric cables					
Check for any damage, replace if needed		X	X		
Safety measures					
Lighting and safety hatched boards – check the condition, function and cleanliness	X		X		
Hazard and safety labels – check that they are installed and legible		X			
Machine lubrication plan					
Drawbar joint / lifting loop – grease	X			X	
Handbrake bolt – grease or suitable oil	X			X	
Axle bearings – grease with Lithium content – check, refill if needed				X	
After season					
Entire machine					
<ul style="list-style-type: none"> • Treat and clean the machine; do not spray oil or similar agents on the plastic parts • Spray the piston-rods of the hydraulic cylinders with suitable anti-corrosion agents • Check the tightness of all bolt and plug-in connections (see the torque chart) • Check for any damage of the electric cables and replace if needed 					
Brake system					
<ul style="list-style-type: none"> • Preserve the anti-freeze fluid for air-brake systems (about 0.1l), ethanol-free, before the last ride, use fluid recommended by the tractor manufacturer. • Secure the machine against movement by Scotch blocks. • Release the parking brake, release air from the air nozzle and close the brake lines. The service brake must be released during winter so that it does not get stuck on the brake drum 					
Points of lubrication					
Grease the points of lubrication according to the lubrication plan, use grease KP2P-20 Likx , under DIN 51 502					
<p>!!! PREVENTION means removing the problem according to the plan, outside the season, without stress and comfortably before a secondary problem, an accident or a health hazard arises.</p>					

9. MACHINE STORAGE

Long-term machine shutdown:

- Store the machine under a roof if possible.
- Store the machine on a flat and solid surface with sufficient load capacity.
- Clean the machine before storing and conserve so that it is not damaged in any way during storage.
- Park the machine on the axle and on the supporting leg, secure the machine against spontaneous movement using scotch blocks.
- When storing, lower the machine into the lower position using hydraulics.
- **The machine must not rest on the discs and the chisel units.** There is a risk of damage to the working discs or chisel breakage.
- Secure the machine against access of unauthorised persons.

10. MACHINE LUBRICATION SCHEDULE



During machine maintenance and its lubrication, it is necessary to observe the safety regulations.

LUBRICATION POINT	INTERVAL	LUBRICANT
TOW BAR JOINT	<ul style="list-style-type: none"> Once a week Always before the work with the machine Always after the end of the season and before storing the machine 	Grease class NGLI 2 with EP additives
TOWING LOOP	<ul style="list-style-type: none"> Once a week Always before the work with the machine Always after the end of the season and before storing the machine 	Grease class NGLI 2 with EP additives
AXLE PINS	<ul style="list-style-type: none"> Once a week Always before the work with the machine Always after the end of the season and before storing the machine 	Grease class NGLI 2 with EP additives

- Points of lubrication are marked:



- When it is difficult to apply the grease into the point of lubrication despite pressing the grease gun strenuously, try turning the joint while pressing the grease gun lever.

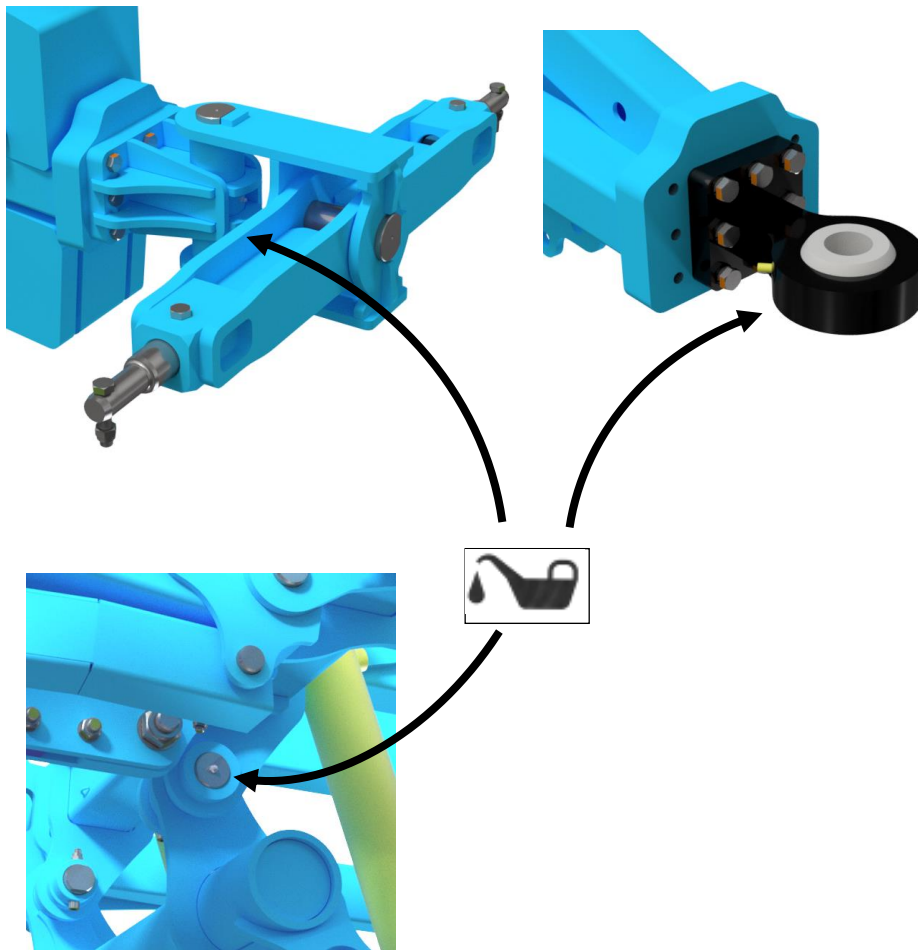

11. ENVIRONMENTAL PROTECTION

- Regularly check the tightness of the hydraulic system.
- Preventively replace or repair hydraulic hoses, possibly further parts of the hydraulic system showing signs of damage, before oil leaks occur.
- Check the condition of hydraulic hoses and perform their timely replacement. The service life of hydraulic hoses includes the time, when they were stored.
- Handle oils and greases according to valid waste laws and regulations.

12. MACHINE DISPOSAL AFTER SERVICE LIFE EXPIRY

- The operator must secure during machine disposal that steel parts and parts, in which hydraulic oil or lubricating grease moves are differentiated.
- Steel parts must be cut by the operator while observing safety regulations and handed over to the secondary raw material collection point. He must proceed with other parts according to valid laws about waste.

13. SERVICING AND WARRANTY CONDITIONS

13.1 SERVICING

- 13.1.1** Servicing is secured by the dealer after consulting with the manufacturer, possibly directly by the manufacturer. Spare parts then using the sales network by individual sellers in the entire country. Use only the spare parts according to the spare parts catalogue officially issued by the manufacturer.

13.2 WARRANTY

- 13.2.1** The manufacturer provides a warranty of 24 months for these machine parts: main frame, axle, and machine tow bar. For other parts of the machine, the manufacturer provides a warranty of 12 months. The warranty is provided from the date of sale of the new machine to the end user (consumer).
- 13.2.2** The warranty applies to hidden defects that will show in the warranty period with proper use of the machine and while fulfilling the conditions stated in the operating manual.
- 13.2.3** The warranty does not apply to wearable spare parts, i.e. regular mechanical wear and tear of replaceable parts of the working sections (shares, edges, etc.).
- 13.2.4** The warranty does not apply to indirect consequences of possible damage, such as service life decrease etc.
- 13.2.5** The warranty is bound to the machine and is not void upon an owner change.
- 13.2.6** The warranty is limited to the disassembly and assembly, possibly replacement or repair of the defective part. The decision, whether to replace or repair the defective part, is up to the contractual workshop of Farmet.
- 13.2.7** During the warranty period, only the authorised servicing technician of the manufacturer may perform repairs or other interventions into the machine. In the opposite case, the warranty will not be acknowledged. This provision does not apply to the replacement of wearable spare parts (see point 13.2.3).
- 13.2.8** The warranty is conditioned by using the genuine spare parts of the manufacturer.

(CZ) **ES PROHLÁŠENÍ O SHODĚ**
 (GB) **CE CERTIFICATE OF CONFORMITY**
 (D) **EG-KONFORMITÄTSERKLÄRUNG**
 (F) **DÉCLARATION CE DE CONFORMITÉ**
 (RU) **СЕРТИФИКАТ СООТВЕТСТВИЯ ЕС**
 (PL) **DEKLARACJA ZGODNOŚCI WE**

1. (CZ) My (GB) We (D) Wir (F) Nous (RU) Мы (PL) My: **Farmet a.s.**
 Jiřinková 276
 552 03 Česká Skalice
 Czech Republic
 DIČ: CZ46504931
 Tel/Fax: 00420 491 450136

(CZ) Vydáváme na vlastní zodpovědnost toto prohlášení. (GB) Hereby issue, on our responsibility, this Certificate. (D) Geben in alleiniger Verantwortung folgende Erklärung ab. (F) Publiions sous notre propre responsabilité la déclaration suivante. (RU) Под свою ответственность выдаем настоящий сертификат. (PL) Wydajemy na własną odpowiedzialność niniejszą Deklarację Zgodności.

2. (CZ) Strojní zařízení: - název : **Kypřič**
 (GB) Machine: - name : **Cultivator**
 (D) Fabrikat: - Bezeichnung : **Grubber**
 (F) Machinerie: - dénomination : **Cultivateur**
 (RU) Сельскохозяйственная машина: - наименование : **Культиватор**
 (PL) Urządzenie maszynowe: - nazwa : **Spulchniarka**

- typ, type : **TRITON**
 - model, modèle : **TRITON 300 P**
 - PIN/VIN:

- (CZ) výrobní číslo :
 - (GB) serial number
 - (D) Fabriknummer
 - (F) n° de production
 - (RU) заводской номер
 - (PL) numer produkcyjny

3. (CZ) Příslušná nařízení vlády: č.176/2008 Sb. (směrnice 2006/42/ES). (GB) Applicable Governmental Decrees and Orders: No.176/2008 Sb. (Directive 2006/42/ES). (D) Einschlägige Regierungsverordnungen (NV): Nr.176/2008 Slg. (Richtlinie 2006/42/ES). (F) Décrets respectifs du gouvernement: n°.176/2008 du Code (directive 2006/42/CE). (RU) Соответствующие постановления правительства: № 176/2008 Сб. (инструкция 2006/42/ES). (PL) Odpowiednie rozporządzenia rządowe: nr 176/2008 Dz.U. (Dyrektywa 2006/42/WE).

4. (CZ) Normy s nimiž byla posouzena shoda: (GB) Standards used for consideration of conformity: (D) Das Produkt wurde gefertigt in Übereinstimmung mit folgenden Normen: (F) Normes avec lesquelles la conformité a été évaluée: (RU) Normы, на основании которых производилась сертификация: (PL) Normy, według których została przeprowadzona ocena: ČSN EN ISO 12100, ČSN EN ISO 4254-1.

(CZ) Schválil (GB) Approve by dne: 01.07.2020
 (D) Bewilligen (F) Approuvé
 (RU) Утвердил (PL) Uchwalit

V České Skalici dne: 01.07.2020

Ing. Petr Lukášek
 technický ředitel
 Technical director

Ing. Karel Žďárský
 generální ředitel společnosti
 General Manager



Farmet a.s.
 Jiřinková 276
 552 03 Česká Skalice
 DIČ CZ46504931
 59

